

Off-Road Protector

Protects headlamps and radiator from the damage of chipping stone!



111 Head Lamp Protector

P/N:5-8676-1110-1

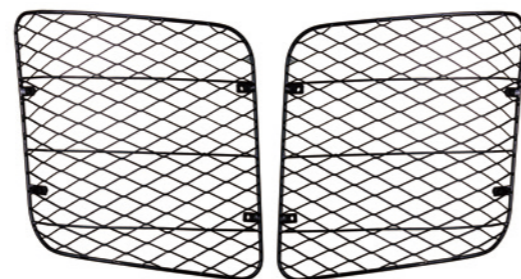

112 Radiator Under Guard

P/N:5-8676-1112-0



113 Radiator Front Guard

P/N:5-8676-1111-0



C&E-SERIES ACCESSORIES

■ Aerodynamics & Economy ■ Safety ■ Functional ■ Exterior ■ Interior ■ Off-Road Protector



ISUZU A&S Co., Ltd. reserves the right to change specifications and equipment without notice. Details of specifications and equipment mentioned or shown in this catalogue are also subject to change to meet local conditions and government requirements. Please inquire at your local ISUZU dealer for more complete details of any such changes that may be required.

Note: Actual vehicle body colour may vary slightly from the colours in the photographs printed in this catalogue. Some of the accessories and equipment shown in this catalogue have been used for photo shooting purposes only and are not equipped on the actual vehicles.

Please ensure that your motor insurance policy provides adequate coverage for additionally fitted accessories.

All rights reserved. No part of this catalogue may be reproduced in any form or by any means without the prior written permission of ISUZU A&S Co., Ltd.

Some accessories and equipment shown in this catalogue may not meet your local conditions and government requirements.

P/N(Part Number) shown in this catalogue is subject to change due to specification changes.

All accessories are designed to install Japanese vehicle specifications. Therefore, some accessories may not be able to install due to local specification differences.



ISUZU A&S Co., Ltd.

<https://www.ias-isuzu.co.jp/en/>
1-2-5 Takashima, Nishi-ku, Yokohama,
Kanagawa 220-0011 JAPAN
Contact : ias_japan@ias.isuzu.com

C&E22ACC-2

August 22 Printed in Japan

Aerodynamics & Economy

Pursing fuel efficiency in long-distance transportation



TYPE-G (Variable-type)

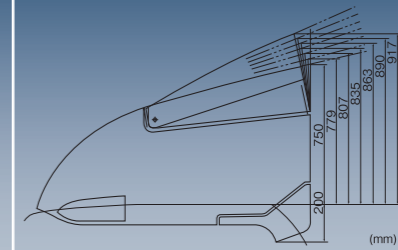

1 Air Deflector TYPE-G Variable-type

- With LED Lamp Signboard
P/N: 1-8671-1120-5 Installation Time: 1.7H Weight: 58.6kg
Material: Resin(FRP)
- Without LED Lamp Signboard
P/N: 1-8671-1119-5 Installation Time: 1.4H Weight: 56.2kg
Material: Resin(FRP)

*Cannot be equipped along with the Front Visor (stainless), Chromed Roof Side Grips, or any Ladder not designed for the Type-G. *Costs for adding text to the Signboard are not included.

2 Gap Shield For TYPE-G

- P/N: 1-8671-1127-2
Installation Time: 0.9H Weight: 5.0kg
Material: Resin(FRP)

*For Air Deflector TYPE-G only.



TYPE-B

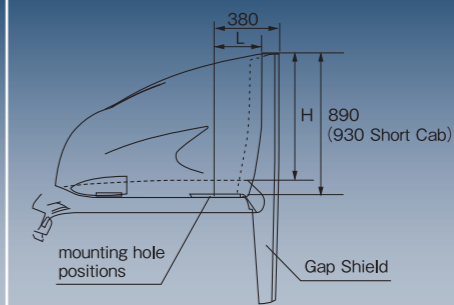

3 Air Deflector TYPE-B Fixed-type

- With LED Lamp Signboard
P/N: 1-8671-1126-4 Installation Time: 1.6H Weight: 45.5kg
Material: Resin(FRP)
- Without LED Lamp Signboard
P/N: 1-8671-1125-2 Installation Time: 1.3H Weight: 42.5kg
Material: Resin(FRP)

*Cannot be installed along with Front Visor (stainless) or Chromed Roof Side Grips.
*Costs for adding text to the Signboard are not included.

4 Gap Shield For TYPE-B

- P/N: 1-8671-1128-3
Installation Time: 1.0H Weight: 6.5kg

*For Air Deflector TYPE-B only.



TYPE-B (For Refrigerator Vehicle)

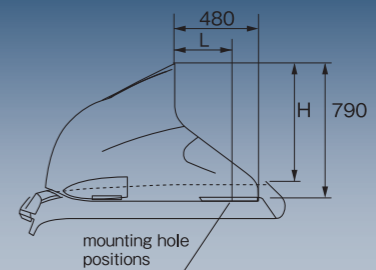

5 Air Deflector TYPE-B For Refrigerator Vehicle

- With LED Lamp Signboard
P/N: 1-8671-1109-5 Installation Time: 1.3H Weight: 28.6kg
- Without LED Lamp Signboard
P/N: 1-8671-1061-4 Installation Time: 1.0H Weight: 25.5kg

*The shape of the evaporator may prevent installation.
*Cannot be installed along with Front Visor (stainless), Chromed Roof Side Grips, or a Gap Shield.
*May affect the cooling performance of integrated evaporator-condenser units.
*Costs for adding text to the Signboard are not included.



Safety

Better safety and greater visibility



6 Drive Recorder Set (IDR-1200)

● **Harness Type (IDR-1200)** P/N:1-8677-4729-0 Installation Time:1.0H
 Additional Interior Camera (P/N:1-8677-4731-0 Installation Time:0.5H)
 Viewer Software (P/N:1-8677-4732-0)
 Additional SD Card for Recording 32GB (P/N:1-8677-4091-1)
 Additional Connector required for IDR-1200 (P/N:1-8671-4026-0)

7 Battery Lock Nut

P/N:1-8677-4759-0
 Contents: Lock Nut x 2pcs., Black Cap (Antirust) x 2pcs., Washer x 2pcs., Key Adapter, ID Label
 *This product can also be used for N and F series battery (Thread Size: M8 x 1.25)

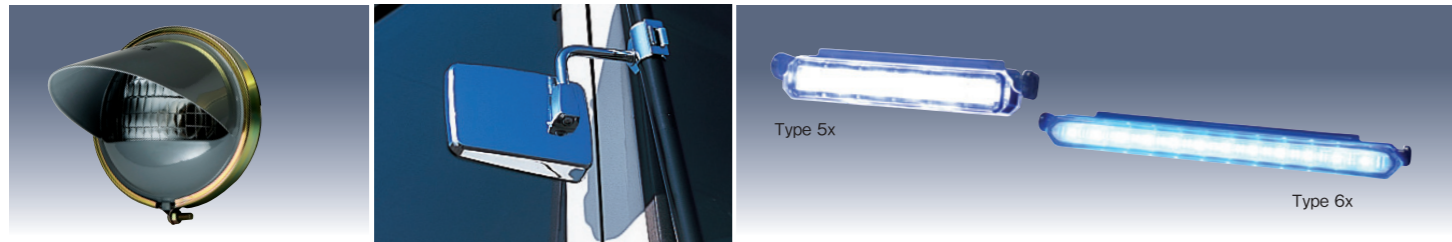

8 Safety Light

● **Right-side** P/N:5-8671-4050-0
 ● **Left-side** P/N:5-8671-4051-0
 Installation Time:0.5H
 *Can only be installed on van-type vehicles.

9 Safety Mirror (Pillar Mirror Type)

P/N:1-8843-4499-4
 Installation Time:0.3H

10 LED Daytime Lamp White/Blue

Installation Time:1.5H
 ● **Type 5x White** P/N:1-8677-3621-0 ● **Type 6x White** P/N:1-8677-3625-0
 ● **Type 5x Blue** P/N:1-8677-3622-0 ● **Type 6x Blue** P/N:1-8677-3626-0
 *Relay harness required for activating/deactivating headlights. (P/N:1-8677-3679-0)

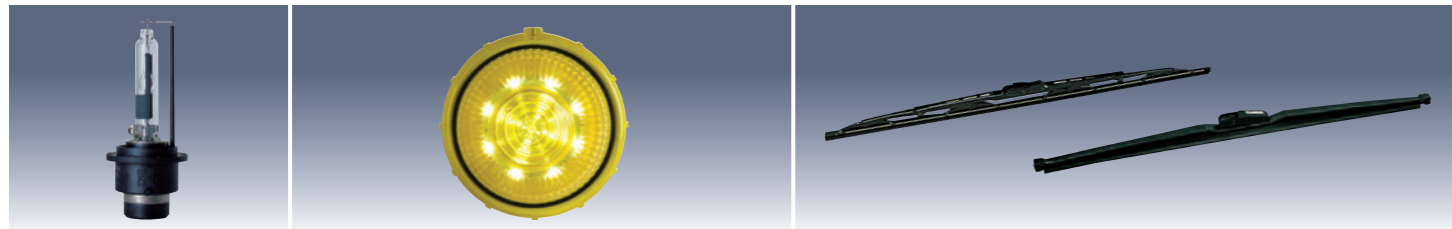

11 HID White Bulb

P/N:1-8677-4190-0
 Installation Time:1.0H
 *5000K type.

12 Waterproof LED Marker Lamp (Yellow)

24V P/N:1-8677-4161-0 Installation Time:*
 *Installation time varies based on installation location and vehicle modification specifications.

13 Windscreen Wiper Blade

Installation Time:0.2H
 ● **Driver Side** P/N:1-8844-6833-0
 ● **Center/Passenger Side** P/N:1-8844-6828-0

14 Snow Wiper Blade

Installation Time:0.2H
 ● **Driver Side** P/N:1-8844-7158-0
 ● **Center/Passenger Side** P/N:1-8844-7156-0

LED Combination Tail lamp

Installation Time:*

*Taillights and brake lights are LED, turn signals are incandescent.
 *Installation time varies based on installation location and vehicle modification specifications.
 *Modification may be required for installation.



15 Suspended/Embedded Type (Clear Square Triple)

P/N:1-8671-4034-2 Weight:3.6kg

16 Suspended/Embedded Type (Square Triple)

P/N:1-8671-4033-1 Weight:3.6kg

17 Suspended Type (Clear Round Triple)

P/N:1-8671-4046-2 Weight:4.8kg



18 Suspended Type (Round Triple)

P/N:1-8671-4045-2 Weight:4.8kg

19 Embedded Type

P/N:5-8678-0820-2 Weight:4.6kg

20 Cover Plate For Van-type Vehicles

1unit Installation Time:0.3H
 ● **Steel(Black)** P/N:5-8678-0676-0
 ● **Stainless** P/N:5-8678-0677-0
 *For Nippon Fruehauf G Cargo only.

Functional

A range of functional accessories for better transport efficiency

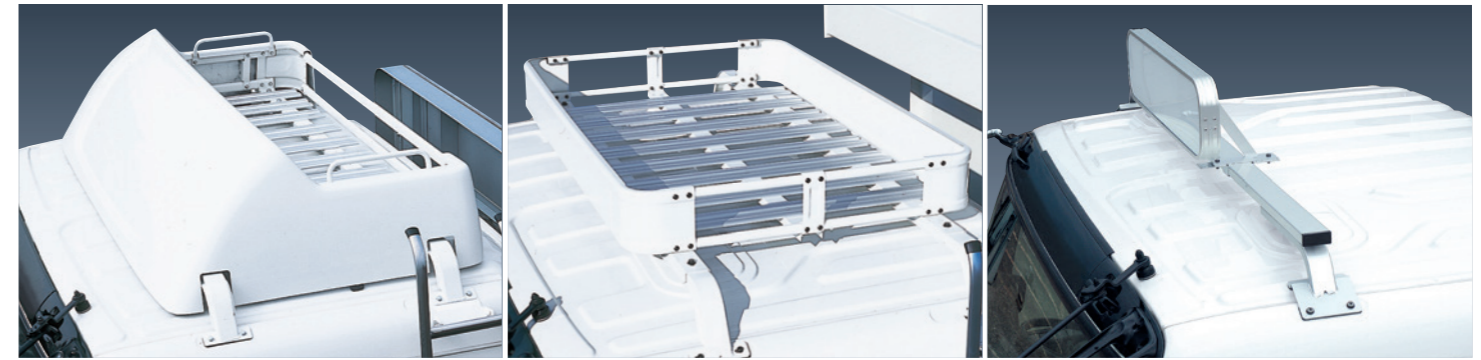

21 Roof Rack

Installation Time:1.8H Weight:45kg
 ● **Cover** P/N:1-8843-4833-1
 ● **mounting bracket** P/N:1-8843-4834-2
 *Maximum Load 35kg

22 Roof Carrier

P/N:1-8671-1064-1
 Installation Time:1.0H Weight:25kg
 *Maximum Load 55kg

23 Multi Stay Base Kit

● **For Mounting Signboard** P/N:1-8671-1115-0
 Installation Time:0.8H Weight:7.1kg
 ● **For Mounting Rotating lights** P/N:1-8671-1116-0
 Installation Time:0.8H Weight:7.6kg
 *Cannot be equipped along with Air Deflector (Type-G/Type-B), Roof Carriers, Roof Racks, or Chromed Roof Side Grips.
 *Up to two rotating lights can be installed.
 *The Signboard in this picture is sold separately.

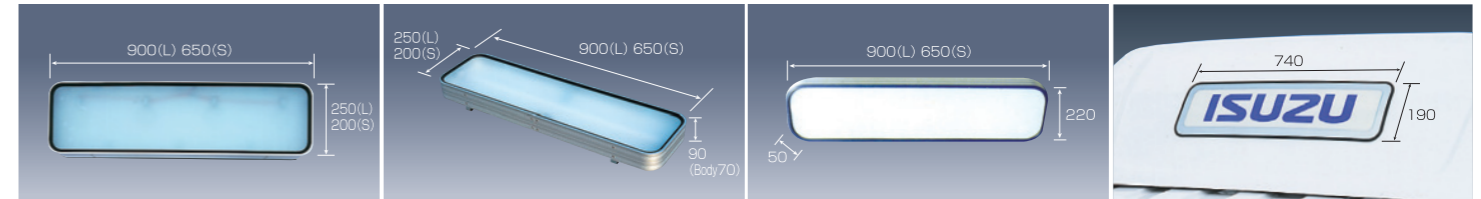

24 Electrical Signboard Aluminium

● **Large** P/N:1-8844-0380-1
 Installation Time:1.0H Weight:3.8kg
 ● **Small** P/N:1-8844-0381-1
 Installation Time:1.0H Weight:2.4kg
 *Costs for adding text are not included
 *Additional connector 2P is required.

25 Signboard

● **Large** P/N:1-8844-7494-0
 Installation Time:1.0H Weight:3.8kg
 ● **Small** P/N:1-8844-7495-0
 Installation Time:1.0H Weight:2.4kg
 *Costs for adding text are not included
 *The lights may generate noise in some regions.
 *Additional connector 2P is required.

26 LED Signboard 24V White

● **Large** P/N:1-8844-8230-3
 Installation Time:1.0H Weight:2.9kg
 ● **Small** P/N:1-8844-8233-3
 Installation Time:1.0H Weight:2.3kg
 *Costs for adding text are not included
 *Additional connector 2P is required.

27 Electric Luminous Signboard

P/N:1-8677-3384-0
 Installation Time:1.0H Weight:0.3kg
 *Costs for adding text are not included
 *Additional connector 2P is required.
 *Installation kit (sold separately; installation time 0.3 hours) required when installing on roof carrier.
 *Installation requires enough surface area to accommodate the signboard size.



28 Front Visor Acrylic (Pillar Mirror Type)

P/N:1-8671-1111-3 Installation Time:1.8H Weight:11.5kg

29 Front Visor Stainless (Pillar Mirror Type)

P/N:1-8843-4792-5 Installation Time:1.3H Weight:19.2kg
 *Cannot be equipped along with an Air Deflector.



30 Door Visors Acrylic (Pillar Mirror Type)

P/N:1-8843-4427-3
 Installation Time:0.7H Weight:0.7kg

31 Door Visors Acrylic Wide (Pillar Mirror Type)

P/N:1-8843-4428-2 Installation Time:0.7H Weight:0.9kg
 *The color is kept light to maintain passenger side visibility.

32 Door Visors Stainless (Pillar Mirror Type)

P/N:1-8843-4429-2
 Installation Time:0.7H Weight:0.5kg

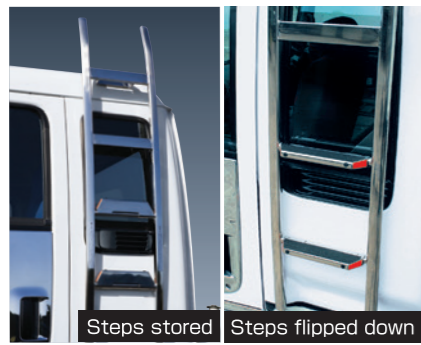

33 Ladder with Flip-down Steps

P/N: 1-8671-1107-1
 Installation Time: 0.6H Weight: 7.5kg
 *Cannot be equipped along with Air Deflector Type-G or G Cargo fixed Air Deflector.
 *The first and second steps are moveable.
 *Maximum Load 150kg



34 Ladder

Stainless / Chromed / Primer

- Stainless type
P/N: 1-8843-4593-5
1unit Installation Time: 0.6H Weight: 5.0kg
- Chromed type
P/N: 1-8843-4595-5
1unit Installation Time: 0.6H Weight: 5.4kg
- Primer type
P/N: 1-8843-4594-5
1unit Installation Time: 0.6H Weight: 5.4kg

*Cannot be equipped along with Air Deflector Type-G or G Cargo fixed Air Deflector.
 *Additional costs are required for primer painting.
 *Maximum Load 80kg



35 Ladder For Air Deflector TYPE-G Variable-type

●Steel type
P/N: 1-8671-2075-3 Weight: 5.5kg
 1unit Installation Time: 0.6H
 *Maximum Load 80kg



36 Cab-back Ladder For Tractor

- Chromed type
P/N: 1-8671-2012-4
1unit Installation Time: 0.5H Weight: 6.4kg
- Primer type
P/N: 1-8671-1053-5
1unit Installation Time: 0.5H Weight: 6.4kg

*Additional costs are required for primer painting.
 *Maximum Load 80kg



37 Chromed Roof Side Grip

P/N: 1-8671-1047-3
 Installation Time: 0.5H Weight: 0.8kg
 *This Chromed Roof Side Grip can be used on both sides of the cab.
 Cannot be equipped along with Air Deflector, Roof Rack, Ladder, or Front Visor.



38 Rear Quarter Glass Film Set

P/N: 1-8671-3011-0
 Installation Time: 0.8H



39 Mosquito Guard

P/N: 1-8672-1067-0
 *Cannot be used while driving.



40 Mud Flap ISUZU

P/N: 1-8671-1153-0
 1unit Installation Time: 0.4H
 Weight: 1.0kg
 Size: W600mm x H900mm

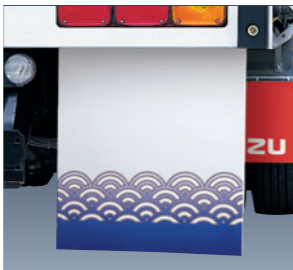

41 Mud Flap Wave Design

P/N: 1-8671-1154-0
 1unit Installation Time: 0.4H
 Weight: 1.0kg
 Size: W600mm x H900mm



42 Mud Flap Small / ISUZU

P/N: 1-8671-1155-0
 1unit Installation Time: 0.4H
 Weight: 0.5kg
 Size: W570mm x H450mm



43 Mud Flap Stay

- Stainless type
P/N: 1-8671-1097-2
1unit Installation Time: 0.6H
Weight: 1.4kg
- Chromed type
P/N: 1-8671-1098-4
1unit Installation Time: 0.6H
Weight: 1.4kg



44 Support Equipment (Excellent "90")

variations are available
 *Installation time varies based on vehicle modification specifications.

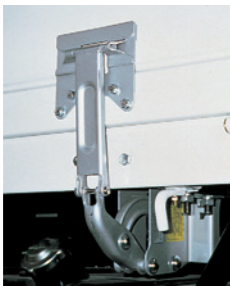

45 Support Equipment (Excellent "Mighty")

variations are available
 *Installation time varies based on vehicle modification specifications.

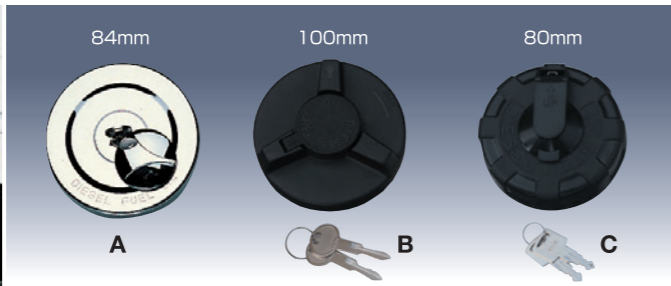

46 Fuel Tank Cap with Key

- A: Chromed(84mm) 2-hook type (Steel tank) P/N: 1-8672-1054-5
- B: Resin(100mm) P/N: 1-8671-1100-1 *For Hoei steel tanks.
- C: Resin(80mm) P/N: 1-8671-1099-1 *For Hoei aluminum tanks.



47 Urea Tank Cap with Keys

P/N: 1-8677-3850-1
 For vehicles with urea tanks (vehicles with 6H engines).

By operating an electric compressor with the battery, this idling stop cooler keeps the cabin cool even when the engine is off.



48 i-Cool Plus (Idling Stop Cooler)

Installation Time : 7.0H~ Weight : 63.0kg~
 *Additional connector harness is required.
 *Because of the device weight, inspections for structural changes, etc. (reduction of tonnage) is required for registered vehicles.
 *Use of i-Cool Plus will shorten the life of the battery. Increasing battery capacity is recommended.
 *Removal of the Chromed Roof-side Grips is required for standard roof vehicles equipped with steps.

49 i-Charge (Charging Battery)

Installation Time : *
 *Using i-Charge in the winter allows extended use of the Portable Electric Blanket.
 *Installation time is 1.0 hour when being installed along with the i-Cool, or 2.5 hours when being installed alone.



50 Parking Heater Webasto

Installation Time : *
 *Installation must be approved by authorized installer.
 *Additional connector harness is required.



51 Parking Heater Eberspaecher Smart timer

P/N: 1-8677-4078-0
 Installation Time : *

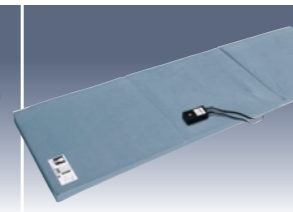

52 Heat-storing Napping Mat-A (with outlet)

P/N: 1-8677-3529-0
 Size : W510xL1950xH50mm
 *Cannot be installed on short cabs.

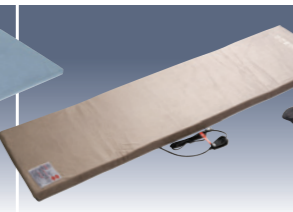

53 Heat-storing Napping Mat-B (with outlet)

P/N: 1-8677-3385-0
 Size : W520xL1900xH45mm
 *Cannot be installed on short cabs.



54 Portable Electric Blanket

P/N: 1-8677-3907-0
 Size : W1200xL2000xT15mm
 *Blanket is washable.



55 Tool Box Stainless

- For 500mm size
P/N: 1-8844-7213-5
Installation Time:* Weight: 6.4kg
 - For 750mm size-A
P/N: 1-8844-7214-5
Installation Time:* Weight: 8.5kg
 - For 750mm size-B
P/N: 1-8844-7215-5
Installation Time:* Weight: 14.6kg
 - For 900mm size
P/N: 1-8844-7216-5
Installation Time:* Weight: 15.1kg
- *Installation time varies based on installation location and vehicle modification specifications.
 *Tool box installation brackets required.

Tool Box Installation Brackets
 ●For 500mm/700mm size-A Tool Box
P/N: 1-8844-7321-0
 ●For 750mm size-B/900mm Tool Box
P/N: 1-8844-7320-0

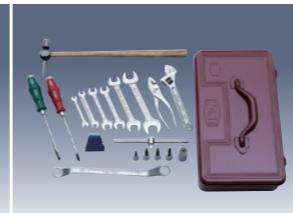

56 Tool Set

P/N: 1-8677-3390-3
 Contents: Steel case, set of six open-end wrenches, pliers 150, crescent wrench 200, Phillips screwdriver 150, flat head screwdriver 150, Torx wrench T25, Torx wrench T30, Torx wrench T40, Torx wrench T50, box wrench 17x19, sliding T-handle, universal socket, inspection hammer



57 Switch & Harness Set for Bodyworks

- Push-type
P/N: 1-8843-4575-0
 - Seesaw-type
P/N: 1-8843-4576-0
- Installation Time : *
 *ISUZU Relay and harness required.
 *Installation time varies based on installation location and vehicle modification specifications.



58 Air Suspension Control Switch Storage Box

P/N: 1-8671-1054-1
 Installation Time : * Weight: 1.5kg
 *For vehicles with air suspensions.
 *Remote control harness required.
 *Installation time varies based on installation location and vehicle modification specifications.



59 Support Equipment (For Dump Trucks)

variations are available
 Installation Time : *
 *Installation time varies based on vehicle modification specifications.

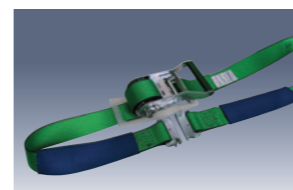

60 Lashing Belt (Ratchet Type)

variations are available



61 Emergency Tool

P/N: 1-8677-4117-0



62 Working Light Set

P/N: 5-8671-4048-2
 Installation Time : 0.7H



63 Removable Working Light

24V P/N: 1-8844-0317-1
 Installation Time : 0.6H
 *Removable working light harness kit is required.

Exterior

A premium exterior for your C&E



64 Chromed Roof Ornament Panel
P/N:1-8671-2074-0 Installation Time:0.5H



69 Chromed Front Bumper
P/N:1-8671-2127-0 Installation Time:1.0H Weight:32kg



65 Chromed Surround Grille
P/N:1-8671-2115-0 Installation Time:0.5H Weight:1.8kg

66 Chromed Open Lid Side Set
Right P/N:1-8671-2129-0 Left P/N:1-8671-2130-0 Installation Time:0.3H



67 Billet Grille For front grille
P/N:1-8671-1162-0 Installation Time:1.0H

68 Billet Grille For bumper
P/N:1-8671-1163-0 Installation Time:0.7H



70 Chromed Air Dam Spoiler
P/N:1-8671-2128-1 Installation Time:1.0H Weight:4.5kg
*Cannot be installed on dump trucks, concrete mixer trucks, low-bed three/four-axle trucks with leaf spring suspensions.
*Air dam spoiler installation stay set required when installing on vehicle equipped with standard bumper without air dam.



71 Front Lip Spoiler
P/N:1-8671-1164-0 Installation Time:1.0H Weight:2.2kg
*Cannot be installed on low-bed three/four-axle trucks with leaf spring suspensions.
*Additional parts required when installing on vehicle equipped with standard bumper without air dam.



72 Chromed Bumper Grille Molding
P/N:1-8671-2114-0 Installation Time:0.5H



73 Chromed Corner Vent Set

Right P/N:1-8671-2124-0
Left P/N:1-8671-2125-0
Installation Time:0.4H

74 Chromed Plate Set
P/N:1-8671-2122-0 / 18671-2123-0
Installation Time:0.4H

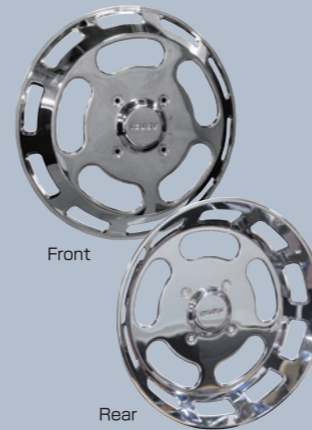

Front

Rear

75 Chromed A-Pillar Set

P/N:1-8672-2050-4
Installation Time:0.4H
*Cannot be equipped on vehicles with side cameras.

76 Chromed Wheel Cap

Sold separately (1unit)
●19.5 inch
Front P/N:1-8671-2120-0
Installation Time:0.1H
Front Bracket P/N:1-8671-1168-3
Installation Time:0.5H
Rear P/N:1-8671-2135-0
Installation Time:0.1H
Rear Bracket P/N:1-8671-1171-5
Installation Time:0.5H
●22.5 inch
Front P/N:1-8671-2118-0
Installation Time:0.1H
Front Bracket P/N:1-8671-1166-3
Installation Time:0.5H
Rear P/N:1-8671-2137-0
Installation Time:0.1H
Rear Bracket P/N:1-8671-1172-3
Installation Time:0.5H



82 Chromed Door Blister Fender Set

P/N:1-8671-2136-0
Installation Time:0.8H

83 Chromed Fender Panel Cover Set

P/N:1-8843-4741-5
Installation Time:0.4H

84 Chromed Door Under Panel Set

P/N:1-8671-2050-2
Installation Time:0.4H Weight:1.3kg

85 Chromed Mud Fender Guard

P/N:1-8671-2072-0
Installation Time:0.8H Weight:1.6kg
*Cannot be installed on front two-axle vehicles.



77 Chromed Mirror Stay (Pillar Mirror Type)

●For heater type
Sold separately (1unit) Right P/N:1-8671-2098-0 Installation Time:0.6H
Sold separately (1unit) Lift P/N:1-8671-2099-0 Installation Time:0.6H
●For heater and wiper type
Sold separately (1unit) Right P/N:1-8671-2105-0 Installation Time:0.6H
Sold separately (1unit) Lift P/N:1-8671-2106-0 Installation Time:0.6H
●For mirror adjustment remote control type
Sold separately (1unit) Right P/N:1-8671-2107-0 Installation Time:0.6H
Sold separately (1unit) Lift P/N:1-8671-2108-0 Installation Time:0.6H

78 Chromed Mirror Cover

●For heater type
Sold separately (1unit) Right P/N:1-8671-2100-1 Installation Time:0.4H
Sold separately (1unit) Lift P/N:1-8671-2101-2 Installation Time:0.4H
●For heater and wiper type
Sold separately (1unit) Right P/N:1-8671-2109-1 Installation Time:0.4H
Sold separately (1unit) Lift P/N:1-8671-2110-2 Installation Time:0.4H
●For mirror adjustment remote control type (Standard Roof / High Roof)
Sold separately (1unit) Right P/N:1-8671-2111-1 Installation Time:0.4H
Sold separately (1unit) Lift P/N:1-8671-2112-1 Installation Time:0.4H

79 Chromed Under Mirror Cover

●Round
P/N:1-8843-0987-1 Installation Time:0.3H
●Square (Side Under)
P/N:1-8843-0744-3 Installation Time:0.3H



80 Chromed Door Handle Cover
P/N:1-8671-2117-1 Installation Time:0.2H
*For driver side only.



81 Chromed Ventilator Panel Set
P/N:1-8672-2051-3 Installation Time:0.3H
*Cannot be equipped along with the Ladder.

86 Chromed Step Under Cover Set

P/N:1-8671-2087-0
Installation Time:0.6H
*Cannot be installed on front two-axle vehicles.
*Can only be installed on standard vehicles equipped with Air Dam Front Bumpers.

87 Chromed Step Panel Set

P/N:1-8671-2052-4
Installation Time:0.5H Weight:2.5kg
*Cannot be installed on CXG, CYG, or firetruck models.



Interior

A comfortable and functional cab to reduce fatigue on long hauls



88 Pleated Round Curtain Deodorizing
 P/N:1-8671-3033-2 Installation Time:0.8H Weight:2.1kg
 *Round Curtain Rail Kit is required for round area.
 ●Round Curtain Rail Kit
 P/N:1-8671-3044-0 Installation Time:0.8H



89 Round Curtain
 P/N:1-8671-3036-4 Installation Time:0.8H Weight:1.5kg
 *Round Curtain Rail Kit is required for round area.
 ●Round Curtain Rail Kit
 P/N:1-8671-3044-0 Installation Time:0.8H



90 Round Curtain Complete Shield-type
 P/N:1-8671-3050-1 Installation Time:0.8H Weight:1.5kg
 *Round Curtain Rail Kit is required for round area.
 ●Round Curtain Rail Kit
 P/N:1-8671-3044-0 Installation Time:0.8H



91 Bed Room Curtain
 P/N:1-8671-3039-3 Installation Time:0.6H Weight:0.9kg
92 Bed Room Curtain Complete Shield-type
 P/N:1-8671-3053-1 Installation Time:0.6H Weight:0.9kg



93 Carpet Floor Mat (RHD)
 Gray P/N:1-8671-3017-0 Green P/N:1-8671-3018-3 Material:Nylon

94 Rubber Floor Mat (RHD)
 P/N:1-8843-4807-0 Material:Natural rubber

95 Seat Cover Deluxe (RHD)
 1seat P/N:1-8671-3024-0 Installation Time:0.5H
 2seats P/N:1-8671-3025-0 Installation Time:0.6H Material:Acrylic

96 Seat Cover Standard (RHD)
 1seat P/N:1-8671-3005-1 Installation Time:0.5H
 2seats P/N:1-8671-3006-1 Installation Time:0.6H Material:Acrylic

97 Seat Cover Vinyl Leather (RHD)
 1seat P/N:1-8671-3027-0 Installation Time:0.5H
 2seats P/N:1-8671-3028-0 Installation Time:0.6H Material:Vinyl Leather

98 Seat Cover Leather-like (RHD)
 1seat P/N:1-8671-3048-0 Installation Time:0.5H
 2seats P/N:1-8671-3049-0 Installation Time:0.6H Material:PVC/Polyester

99 Wood-like Panel Meter Cluster (RHD)
 P/N:1-8843-4775-2 Installation Time:0.3H Material:Resin(ABS)
 *Installed as standard on custom vehicles.

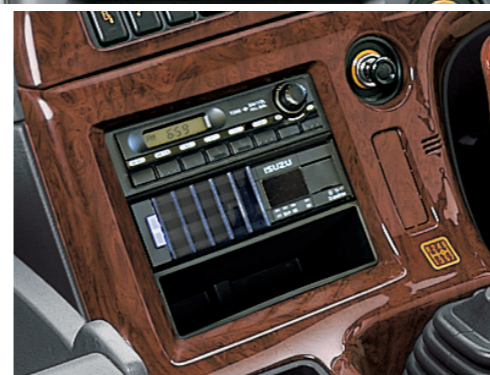

100 Wood-like Panel Console Panel (RHD)
 For MT P/N:1-8671-1080-0 Installation Time:0.4H
 For Smoother P/N:1-8671-3047-0 Installation Time:0.4H



101 Wood-like Panel Door Switch Panel Set (RHD)
 P/N:1-8672-3068-0 Installation Time:0.4H

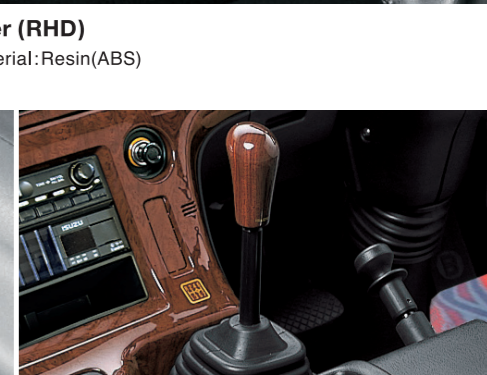

102 Shift Knob Wood (RHD)
 P/N:1-8671-3078-1 Installation Time:0.3H
 *Cannot be installed on vehicles equipped with Smoother G.



103 Wood-like Panel Relay Lid Panel (RHD)
 P/N:1-8671-1081-2 Installation Time:0.4H



104 Interior Panel For MT / For Smoother (RHD)
 For MT P/N:1-8671-3055-0 Installation Time:0.3H
 For Smoother P/N:1-8671-3056-0 Installation Time:0.3H



105 Map Holder
 P/N:1-8843-4468-3 Installation Time:0.7H
 *The passenger side does not have a storage function.
 *Blocks the visibility of the rear quarter windows.



106 Rear Window Box
 P/N:1-8843-4467-1 Installation Time:0.4H Weight:2.5kg
 *Blocks the visibility of the rear windows.



107 Center Multi Rack
 P/N:1-8843-4815-0 Installation Time:0.6H Weight:5.0kg
 *Only available for two-seat vehicles.



108 Instrument Panel Tray (RHD)
 P/N:1-8843-4464-1 Installation Time:0.3H



109 Ashtray (For Cup Holder)
 P/N:1-8844-8512-1

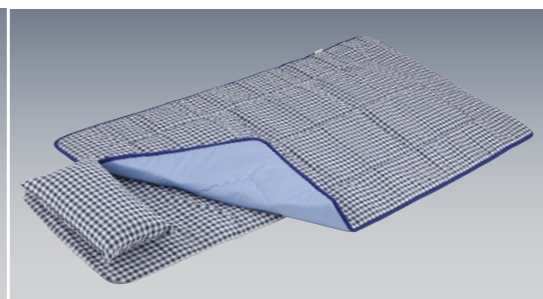

110 Bedding Kit
 P/N:1-8843-4437-1